

FOR OFFICE USE ONLY	CRAFT LINE ORDER FORM	DATE REQ: _____	E.O. <input type="checkbox"/>
----------------------------	------------------------------	-----------------	-------------------------------

SO# _____	CUSTOMER: _____	SPC. INS.: _____
-----------	-----------------	------------------

CUST# _____	TAG: _____	SHIP/W: _____
-------------	------------	---------------

Salesperson: _____	PO#: _____	SDA#: _____
--------------------	------------	-------------

PROFILE: WF UW DW AW SE LBE WE WBE WBN SSDW SSBE SSFE
(Circle One)

CARDBOARD WRAP <input type="checkbox"/>	PB CRATE <input type="checkbox"/>	APPLIED BUILDUP: YES <input type="checkbox"/> NO <input type="checkbox"/>
---	-----------------------------------	---

WOOD TYPE & STAIN: _____	LAMINATE OR SOLID SURFACE BEVEL: _____
COLOR: _____	CODE: _____

FINISHED END OPTIONS

AFE Angle Finished End	FE Laminate Finished End	NLAMFE Non-Laminated Finished End (Wood, WBE, LBE, SS, etc)
BSFE Bar Sweep Finished End	FEMO Finished End Material Only	
RAD Radius Finished End	CFE Core Finished End	

K = with backsplash N = no backsplash L = low backsplash B = Bartop

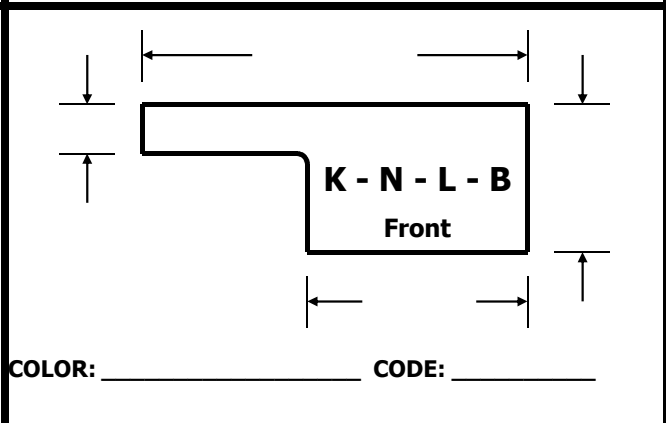
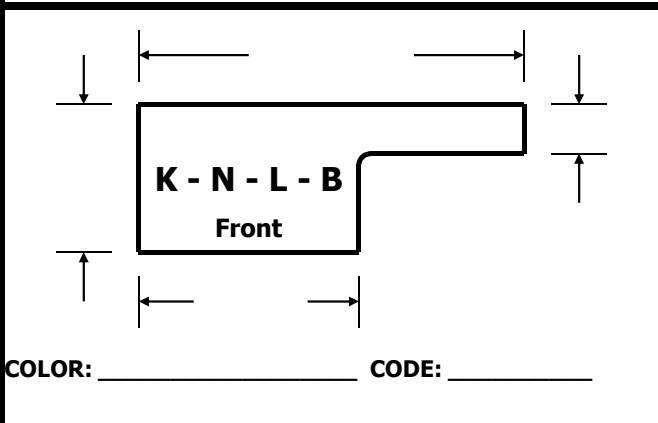
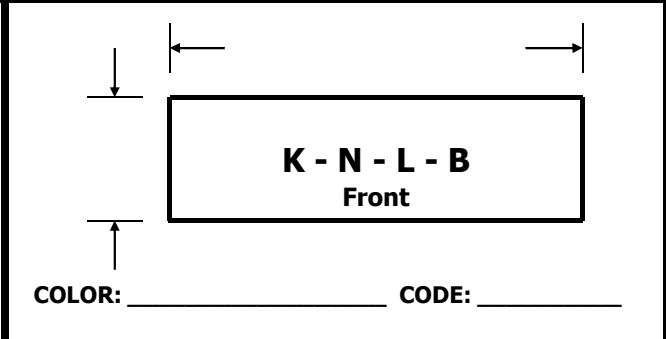
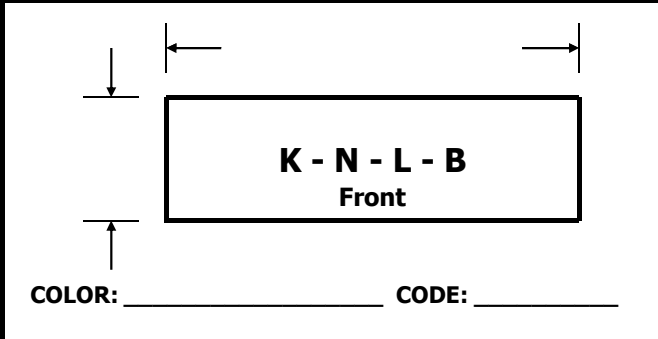
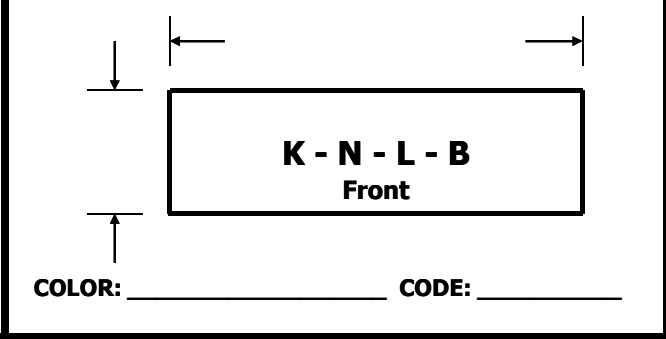
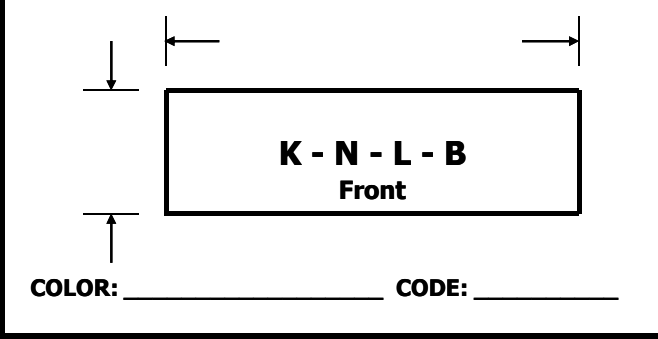

DATE: _____

CORNER (SAME DEPTHS)

PAGE _____ OF _____

FOR OFFICE USE ONLY	CRAFT LINE ORDER FORM	DATE REQ:	E.O. <input type="checkbox"/>
---------------------	-----------------------	-----------	-------------------------------

SO#	CUSTOMER:	SPC. INS.:
-----	-----------	------------

CUST#	TAG:	SHIP/W:
-------	------	---------

Salesperson:	PO#:	SDA#:
--------------	------	-------

PROFILE: (Circle One) WF UW DW AW SE LBE WE WBE WBN SSDW SSBE SSFE

CARDBOARD WRAP <input type="checkbox"/>	PB CRATE <input type="checkbox"/>	APPLIED BUILDUP: YES <input type="checkbox"/> NO <input type="checkbox"/>
---	-----------------------------------	---

WOOD TYPE & STAIN:	LAMINATE OR SOLID SURFACE BEVEL: COLOR: _____ CODE: _____
--------------------	--

FINISHED END OPTIONS

AFE Angle Finished End	FE Laminate Finished End	NLAMFE Non-Laminated Finished End (Wood, WBE, LBE, SS, etc)
BSFE Bar Sweep Finished End	FEMO Finished End Material Only	
RAD Radius Finished End	CFE Core Finished End	

K = with backsplash N = no backsplash L = low backsplash B = Bartop

USE THIS FORM ONLY IF COUNTERTOP DEPTHS ARE THE SAME

<p style="text-align: center;">K - N - L - B Front</p> <p>COLOR: _____</p> <p>CODE: _____</p>	<p>COLOR: _____</p> <p>CODE: _____</p> <p style="text-align: center;">K - N - L - B Front</p> <p>COLOR: _____</p> <p>CODE: _____</p>
--	---

<p style="text-align: center;">K - N - L - B Front</p> <p>COLOR: _____</p> <p>CODE: _____</p>	<p style="text-align: center;">K - N - L - B Front</p> <p>COLOR: _____</p> <p>CODE: _____</p>
--	--

DATE: _____

CORNER KITCHEN - BAR

PAGE _____ OF _____

FOR OFFICE USE ONLY **CRAFT LINE ORDER FORM** DATE REQ: _____ E.O.

SO# _____ CUSTOMER: _____ SPC. INS.: _____

CUST# _____ TAG: _____ SHIP/W: _____

Salesperson: _____ PO#: _____ SDA#: _____

PROFILE: (Circle One) WF UW DW AW SE LBE WE WBE WBN SSDW SSBE SSFE

CARDBOARD WRAP PB CRATE APPLIED BUILDUP: YES NO

WOOD TYPE & STAIN: _____ LAMINATE OR SOLID SURFACE BEVEL: _____
 COLOR: _____ CODE: _____

FINISHED END OPTIONS

AFE Angle Finished End	FE Laminate Finished End	NLAMFE Non-Laminated Finished End (Wood, WBE, LBE, SS, etc)
BSFE Bar Sweep Finished End	FEMO Finished End Material Only	
RAD Radius Finished End	CFE Core Finished End	

K = with backsplash N = no backsplash L = low backsplash B = Bartop

USE IF COUNTERTOP DEPTHS ARE DIFFERENT (Kitchen to Bar)

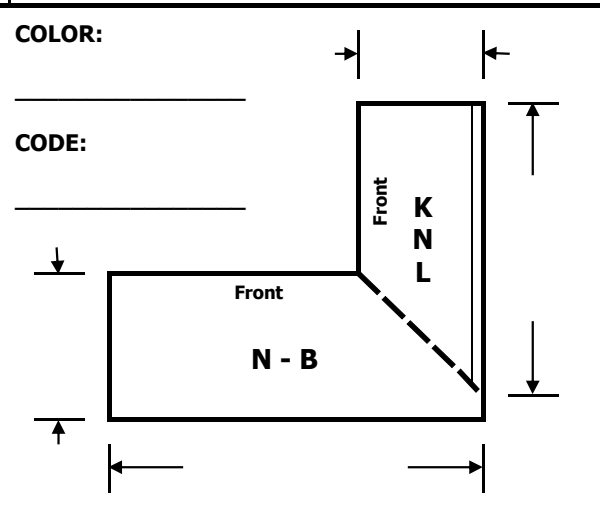
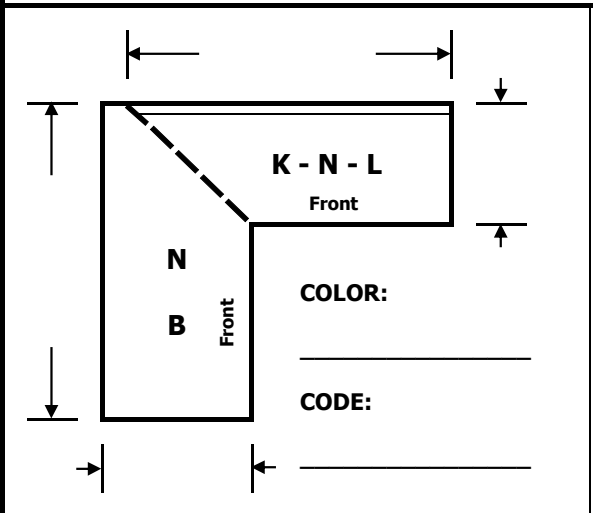
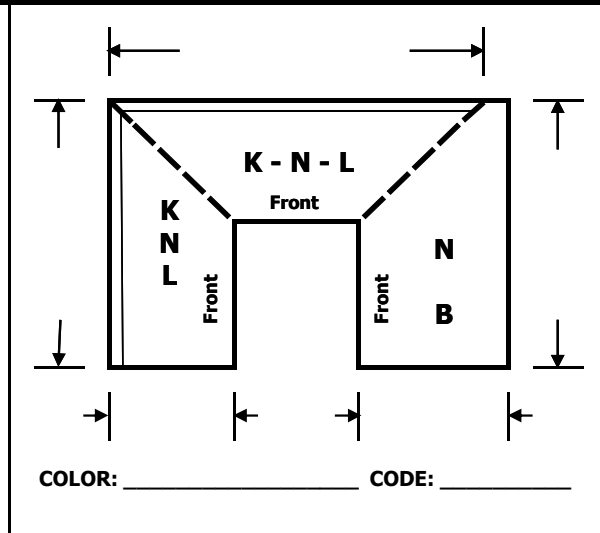
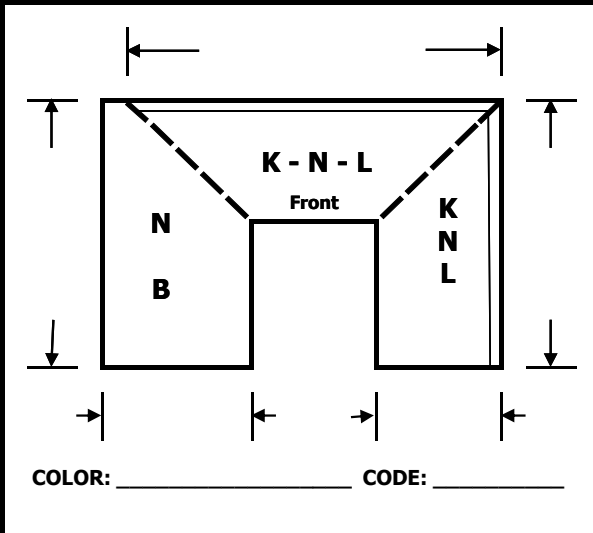

DATE: _____

LAMINATE Angle Corners

PAGE _____ OF _____

FOR OFFICE USE ONLY	CRAFT LINE ORDER FORM	DATE REQ: _____	E.O. <input type="checkbox"/>
----------------------------	------------------------------	-----------------	-------------------------------

SO# _____	CUSTOMER: _____	SPC. INS.: _____
-----------	-----------------	------------------

CUST# _____	TAG: _____	SHIP/W: _____
-------------	------------	---------------

Salesperson _____	PO#: _____	SDA#: _____
-------------------	------------	-------------

PROFILE: (Circle One) WF UW DW AW SE LBE WE WBE WBN SSDW SSBE SSFE

CARDBOARD WRAP <input type="checkbox"/>	PB CRATE <input type="checkbox"/>	APPLIED BUILDUP: YES <input type="checkbox"/> NO <input type="checkbox"/>
---	-----------------------------------	--

WOOD TYPE & STAIN: _____	LAMINATE OR SOLID SURFACE BEVEL: _____
COLOR: _____	CODE: _____

FINISHED END OPTIONS

AFE Angle Finished End	FE Laminate Finished End	NLAMFE Non-Laminated Finished End (Wood, WBE, LBE, SS, etc)
BSFE Bar Sweep Finished End	FEMO Finished End Material Only	
RAD Radius Finished End	CFE Core Finished End	

K = with backsplash N = no backsplash L = low backsplash B = Bartop

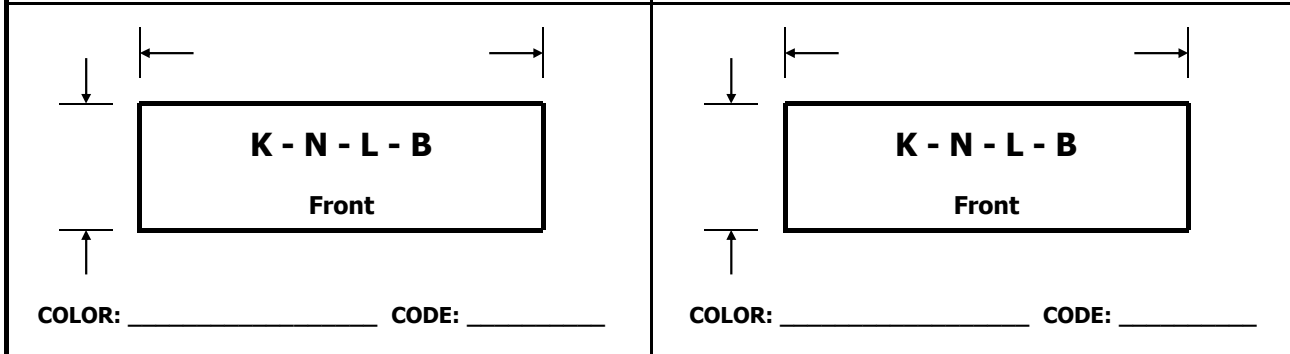
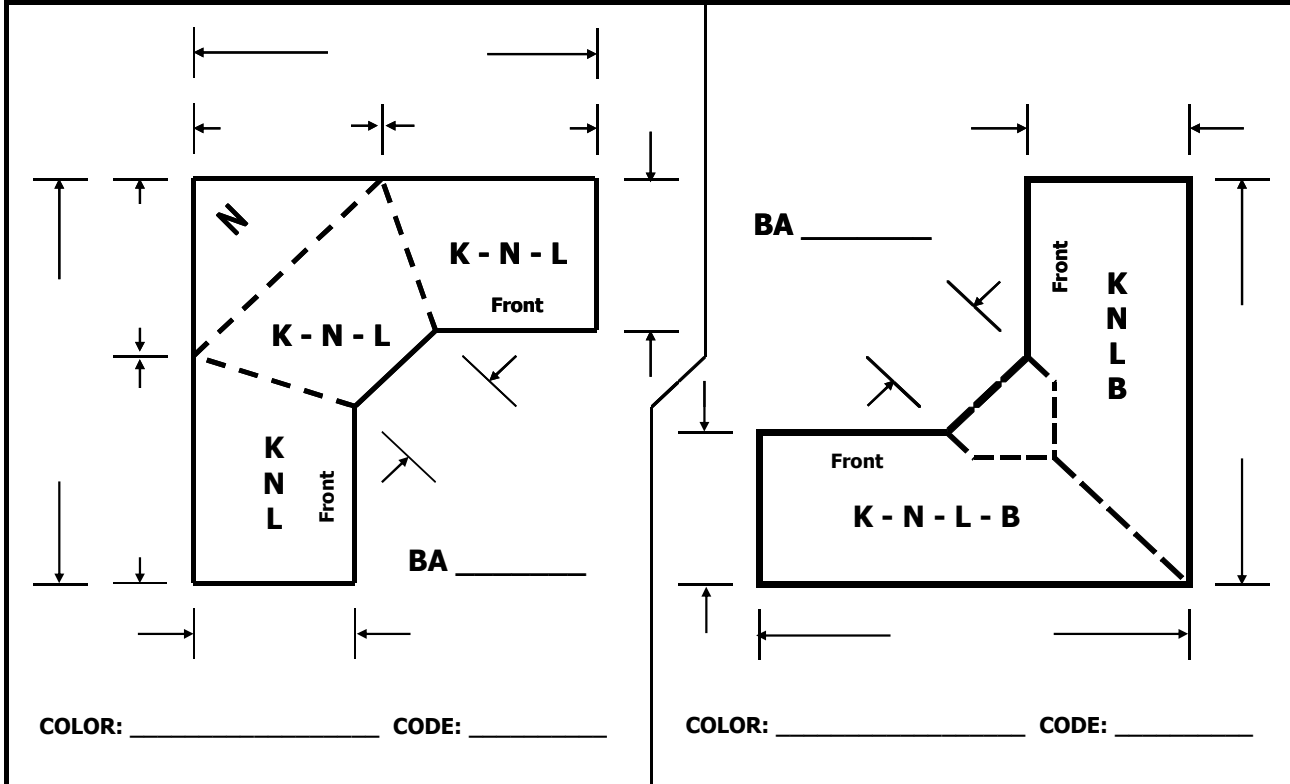

DATE: _____

LAMINATE Custom

PAGE _____ OF _____

FOR OFFICE USE ONLY	CRAFT LINE ORDER FORM	DATE REQ:	E.O.	<input type="checkbox"/>
---------------------	-----------------------	-----------	------	--------------------------

SO#	CUSTOMER:	SPC. INS.:
-----	-----------	------------

CUST#	TAG:	SHIP/W:
-------	------	---------

Salesperson:	PO#:	SDA#:
--------------	------	-------

PROFILE: WF UW DW AW SE LBE WE WBE WBN SSDW SSBE SSFE
(Circle One)

CARDBOARD WRAP <input type="checkbox"/>	PB CRATE <input type="checkbox"/>	APPLIED BUILDUP: YES <input type="checkbox"/> NO <input type="checkbox"/>
---	-----------------------------------	---

WOOD TYPE & STAIN:	LAMINATE OR SOLID SURFACE BEVEL: COLOR: CODE:
--------------------	--

FINISHED END OPTIONS

AFE Angle Finished End	FE Laminate Finished End	NLAMFE Non-Laminated Finished End (Wood, WBE, LBE, SS, etc)
BSFE Bar Sweep Finished End	FEMO Finished End Material Only	
RAD Radius Finished End	CFE Core Finished End	

DATE: _____

TEMPLATE ORDER

PAGE _____ OF _____

FOR OFFICE USE ONLY		CRAFT LINE ORDER FORM		DATE REQ:	E.O.	<input type="checkbox"/>
SO#		CUSTOMER:		SPC. INS.:		
CUST#		TAG:		SHIP/W:		
Salesperson:		PO#:		SDA#:		
PROFILE: WF UW DW AW SE LBE WE WBE WBN SSDW SSBE SSFE (Circle One)						
CARDBOARD WRAP <input type="checkbox"/>		PB CRATE <input type="checkbox"/>		APPLIED BUILDUP: YES <input type="checkbox"/> NO <input type="checkbox"/>		
WOOD TYPE & STAIN:				LAMINATE OR SOLID SURFACE BEVEL:		
				COLOR: CODE:		
THIS ORDER WILL BE MADE EXACTLY TO PROVIDED TEMPLATE						
Please indicate all finished ends and type, etc. on template. Provide rough sketch of (including sizes) of order below. Orders will be <u>made exactly to templated provided</u> , not the information supplied on this order form should it differ.						
Color & Color Code: _____						
CUSTOMER TO COMPLETE THE FOLLOWING INFORMATION:						
Template sent (or being sent) to Craft Line on: _____						
Preorder Non-Stock Laminate: YES <input type="checkbox"/> NO <input type="checkbox"/> <small>Note: If sizes on drawing are incorrect insufficient laminate may be ordered, delaying order and may result in additional laminate charges</small>						
For Template information contact:				Phone:		
Phone: 233-3097 or Toll Free: 877-459-2959				Fax: 237-5993 or 800-431-4769		

FOR OFFICE USE ONLY	CRAFT LINE ORDER FORM	DATE REQ: _____	E.O. <input type="checkbox"/>
----------------------------	------------------------------	-----------------	-------------------------------

SO#	CUSTOMER:	SPC. INS.:
-----	-----------	------------

CUST#	TAG:	SHIP/W:
-------	------	---------

Salesperson:	PO#:	SDA#:
--------------	------	-------

PROFILE: (Circle One) WF UW DW AW SE LBE WE WBE WBN SSDW SSBE SSFE

CARDBOARD WRAP PB CRATE

WOOD TYPE & STAIN:	LAMINATE OR SOLID SURFACE BEVEL:
	COLOUR: _____ CODE: _____

_____ 4 1/2" _____	Endsplash - Style A Butts Up To Countertop	<p>NOTE: Craft Line will modify the length of the top to accommodate this endsplash. For example if there are 2 - Style A Endsplashes needed then Craft Line will deduct the thickness of the endsplashes from the top so that the sum of the three parts will equal your finished length.</p>
	<p style="text-align: center;">19 1/2" - 25 1/2"</p>	
Colour: _____ Code: _____ Length: _____ Qty: _____ (L) Qty: _____ (R)		

_____ 3 1/4" _____	Endsplash - Style B Sits On Countertop	
	<p style="text-align: center;">19 1/2" - 25 1/2"</p>	
Colour: _____ Code: _____ Length: _____ Qty: _____ (L) Qty: _____ (R)		

_____ 3 1/4" _____	Sits On Countertop	This edge will be shaped to the profile
	<p style="text-align: center;">19 1/2" - 25 1/2"</p>	
Colour: _____ Code: _____ Length: _____ Qty: _____ (L) Qty: _____ (R)		

Loose Backsplash	
_____ 3 1/4" _____	<p style="text-align: center;">12" - 144"</p>
Colour: _____ Code: _____ Length: _____ Qty: _____	